

Domestic Cast Threaded Fittings

69140 FACE BUSHINGS		125 lbs.	
SIZE CODE	NOMINAL SIZE	APPROX. NET WT.	DIM. A
0007LF	1/4 X 1/8	0.0115	0.4375*
0058LF	1/2 X 3/8	0.0315	0.5625*
0107LF	3/4 X 1/2	0.0495	0.625*

*Furnished in bar-stock

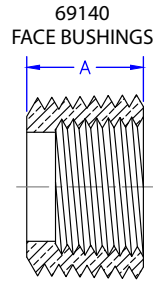

60144 HEX BUSHINGS		125 lbs.			
SIZE CODE	NOMINAL SIZE	APPROX. NET WT.	DIM. A	DIM. B	DIM. C
0007LF	1/4X1/8	0.022	0.594	0.4375	0.66*
0032LF	3/8X1/4	0.033	0.6563	0.5	0.69*
0033LF	3/8X1/8	0.048	0.6563	0.5	0.69*
0058LF	1/2X3/8	0.0535	0.75	0.594	0.88*
0059LF	1/2X1/4	0.0805	0.75	0.594	0.88*
0060LF	1/2X1/8	0.099	0.75	0.594	0.88*
0107LF	3/4X1/2	0.108	0.875	0.625	1.16*
0108LF	3/4X3/8	0.154	0.875	0.625	1.16*
0109LF	3/4X1/4	0.1935	0.875	0.625	1.16*
0110LF	3/4X1/8	0.2075	0.875	0.625	1.16*
0159LF	1x3/4	0.2067	1	0.75	1.42
0160LF	1x1/2	0.264	1	0.75	1.42
0161LF	1x3/8	0.228	1	0.75	1.12
0162LF	1x1/4	0.247	1.1	0.75	1.12
0163LF	1x1/8	0.2076	1.1	0.75	1.12
0222LF	1-1/4x1	0.348	1.1	0.8	1.76
0223LF	1-1/4x3/4	0.4337	1.1	0.8	1.76
0224LF	1-1/4x1/2	0.3738	1.14	0.8	1.34
0225LF	1-1/4x3/8	0.3252	1.14	0.8	1.12
0226LF	1-1/4x1/4	0.3585	1.14	0.8	1.12
0303LF	1-1/2x1-1/4	0.5	1.16	0.83	2
0304LF	1-1/2x1	0.479	1.16	0.83	2
0305LF	1-1/2x3/4	0.4163	1.2	0.83	1.63
0306LF	1-1/2x1/2	0.45	1.2	0.83	1.34
0307LF	1-1/2x3/8	0.45	1.2	0.83	1.13
0308LF	1-1/2-1/4	0.905	1.2	0.83	1.4
0398LF	2x1-1/2	0.88	1.24	0.88	2.48
0399LF	2x1-1/4	0.6482	1.24	0.88	2.48
0400LF	2x1	0.7625	1.29	0.88	1.95
0401LF	2x3/4	0.621	1.29	0.88	1.63
0402LF	2x1/2	0.6633	1.29	0.88	1.34
0404LF	2x1/4	1.2525	1.2	0.88	1.13
0531LF	2-1/2x2	1.2175	1.44	1.07	2.98
0532LF	2-1/2x1-1/2	1.0526	1.51	1.07	2.68

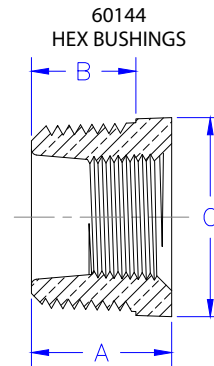

Domestic Cast Threaded Fittings

60144 HEX BUSHINGS (continued)			125 lbs.		
SIZE CODE	NOMINAL SIZE	APPROX. NET WT.	DIM. A	DIM. B	DIM. C
0533LF	2-1/2x1-1/4	1.218	1.51	1.07	2.39
0534LF	2-1/2x1	1.4	1.51	1.07	1.95
0536LF	2-1/2x1/2	1.9	1.55	1.07	1.97
0662LF	3x2-1/2	2.1076	1.55	1.13	3.86
0663LF	3x2-1/2	1.6	1.61	1.13	3.28
0664LF	3x1-1/2	1.6111	1.61	1.13	2.68
0665LF	3x1-1/4	1.52	1.61	1.13	2.39
0666LF	3x1	2.2066	1.57	1.13	1.95
0790LF	3-1/2x3	2.24	1.69	1.13	4.24
0869LF	4x3-1/2	3.1	1.74	1.22	4.63
0870LF	4x3	3.1	1.72	1.22	4.62
0871LF	4x2-1/2	3.1	1.82	1.22	3.86
0872LF	4x2	2.8293	1.82	1.22	3.28
0873LF	4x1-1/2	2.68	1.66	1.22	2.8
0875LF	4x1	4.8	1.66	1.22	2.8

*Furnished in bar-stock

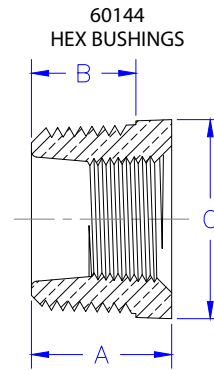

60155 CAPS		125 lbs.	
SIZE CODE	NOMINAL SIZE	APPROX. NET WT.	DIM A
0001LF	1/8	0.0353	0.49
0002LF	1/4	0.0546	0.59
0025LF	3/8	0.0833	0.64
0050LF	1/2	0.1135	0.76
0100LF	3/4	0.19	0.84
0150LF	1	0.313	0.99
0215LF	1-1/4	0.51	1.1
0295LF	1-1/2	0.7335	1.15
0390LF	2	1.147	1.32
0520LF	2-1/2	1.85	1.7
0650LF	3	2.945	1.8
0860LF	4	5.4875	2.08

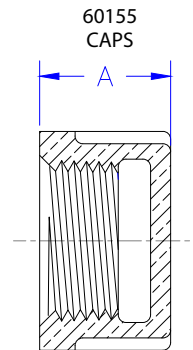

Domestic Cast Threaded Fittings

60165 COUPLINGS		125 lbs.	
SIZE CODE	NOMINAL SIZE	APPROX. NET. WT.	DIM. A
0001LF	1/8	0.053	0.8
0002LF	1/4	0.0727	0.97
0007LF	1/4x1/8	0.0653	0.88
0025LF	3/8	0.127	1.05
0032LF	3/8x1/4	0.1025	1.01
0033LF	3/8x1/8	0.107	0.92
0050LF	1/2	0.1948	1.29
0058LF	1/2x3/8	0.1692	1.17
0059LF	1/2x1/4	0.135	1.13
0060LF	1/2x1/8	0.144	1.13
0100LF	3/4	0.2812	1.43
0107LF	3/4x1/2	0.2506	1.36
0108LF	3/4x3/8	0.225	1.24
0109LF	3/4x1/4	0.212	1.24
0150LF	1	0.449	1.68
0159LF	1x3/4	0.376	1.56
0160LF	1x1/2	0.339	1.49
0161LF	1x3/8	0.324	1.49
0162LF	1x1/4	0.349	1.49
0215LF	1-1/4	0.6233	1.86
0222LF	1-1/4x1	0.544	1.77
0223LF	1-1/4x3/4	0.545	1.65
0224LF	1-1/4x1/2	0.496	1.65
0295LF	1-1/2	0.8088	1.92
0303LF	1-1/2x1-1/4	0.7378	1.87
0304LF	1-1/2x1	0.6663	1.8
0305LF	1-1/2x3/4	0.6237	1.8
0306LF	1-1/2x1/2	0.596	1.8
0390LF	2	1.565	2.2
0398LF	2x1-1/2	1.1208	2.03
0399LF	2x1-1/4	1.152	2.03
0400LF	2x1	1.0117	2.03
0401LF	2x3/4	0.9733	2.03
0402LF	2x1-1/2	1.018	1.94
0520LF	2-1/2	2.305	2.88
0531LF	2-1/2x2	1.864	3.25
0532LF	2-1/2x1-1/2	2.158	3.25
0533LF	2-1/2x1-1/4	2.01	3.25
0650LF	3	3.355	3.18
0662LF	3x2-1/2	3.8	3.69
0663LF	3x2	3.432	3.69
0664LF	3x1-1/2	4.23	3.69
0665LF	3x1-1/4	1.995	3.69
0666LF	3x1	4.75	2.45
0860LF	4	4.9	3.69
0870LF	4x3	6.13	4.38
0872LF	4x2	5.54	4.38
0975LF	5	10.85	4.17
1100LF	6	15.925	4.85
1109LF	6x4	12.6	4.75

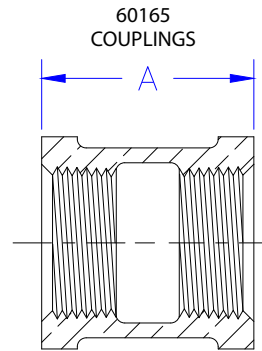

Domestic Cast Threaded Fittings

60195 CROSSES 125 lbs.

SIZE CODE	NOMINAL SIZE	APPROX NET WT.	DIM. A	DIM. B
0001LF	1/8	0.1137	0.54	0.54
0002LF	1/4	0.163	0.71	0.71
0025LF	3/8	0.253	0.82	0.82
0050LF	1/2	0.3625	1.01	1.01
0100LF	3/4	0.568	1.18	1.18
0118LF	3/4x3/4x1/2x1/2	0.4659	1.08	1.11
0150LF	1	0.949	1.43	1.43
0215LF	1-1/4	1.5312	1.69	1.69
0247LF	1-1/4x3/4	0.870	1.48	1.39
0295LF	1-1/2	1.9433	1.84	1.84
0390LF	2	2.95	2.12	2.12
0520LF	2-1/2	6.05	2.7	2.7
0650LF	3	8.251	3.08	3.08
0860LF	4	16.645	3.79	3.79

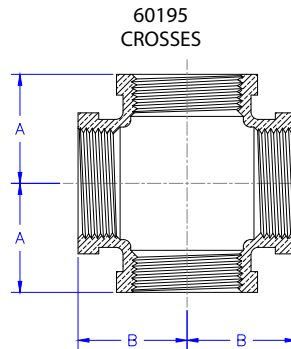

60235 ELBOWS 125 lbs.

SIZE CODE	NOMINAL SIZE	APPROX NET WT.	DIM. A	DIM. B
0001LF	1/8	0.06	0.53	0.53
0002LF	1/4	0.102	0.71	0.71
0007LF	1/4x1/8	0.086	0.65	0.6
0025LF	3/8	0.186	0.82	0.82
0032LF	3/8x1/4	0.1258	0.75	0.78
0033LF	3/8x1/8	0.127	0.75	0.78
0050LF	1/2	0.229	1.01	1.01
0058LF	1/2x3/8	0.1771	0.93	0.9
0059LF	1/2x1/4	0.1704	0.87	0.87
0100LF	3/4	0.335	1.18	1.18
0107LF	3/4x1/2	0.313	1.08	1.11
0108LF	3/4x3/8	0.875	0.97	0.97
0109LF	3/4x1/4	0.2394	0.94	1
0150LF	1	0.5544	1.43	1.43
0159LF	1x3/4	0.543	1.3	1.31
0160LF	1x1/2	0.4479	1.2	1.24
0161LF	1x3/8	0.39	1.12	1.13
0162LF	1x1/4	0.4065	1.12	1.13
0215LF	1-1/4	0.9117	1.69	1.69
0222LF	1-1/4x1	0.794	1.52	1.6
0223LF	1-1/4x3/4	0.6816	1.39	1.48
0224LF	1-1/4x1/2	0.7153	1.29	1.41
0295LF	1-1/2	1.3883	1.84	1.84
0303LF	1-1/2x1-1/4	1.004	1.72	1.81
0304LF	1-1/2x1	0.9645	1.55	1.72
0305LF	1-1/2x3/4	0.884	1.42	1.6
0306LF	1-1/2x1/2	0.94	1.32	1.53
0390LF	2	2.2416	2.12	2.12
0398LF	2x1-1/2	1.725	1.89	2.07

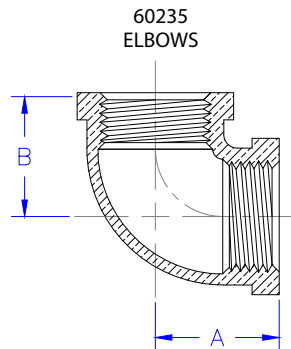

Domestic Cast Threaded Fittings

60235 ELBOWS (continued) 125 lbs.

SIZE CODE	NOMINAL SIZE	APPROX NET WT.	DIM. A	DIM. B
0399LF	2x1-1/4	1.4766	1.77	2.04
0400LF	2x1	1.4561	1.59	1.95
0401LF	2x3/4	1.5455	1.47	1.84
0402LF	2x1/2	1.6	1.49	1.88
0520LF	2-1/2	3.387	2.7	2.7
0531LF	2-1/2x2	3.015	2.39	2.6
0532LF	2-1/2x1-1/2	2.92	2.16	2.51
0650LF	3	5.335	3.08	3.08
0662LF	3x2-1/2	4.5143	2.83	2.99
0663LF	3x2	3.8	2.52	2.89
0860LF	4	9.015	3.79	3.79
0975LF	5	17.2	4.5	4.5
1100LF	6	25.9	5.13	5.13

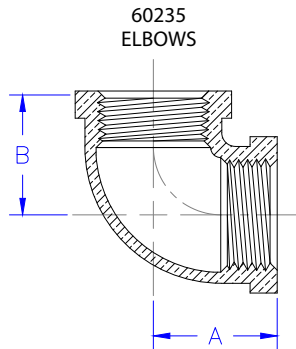

60240 90° DROP ELBOWS 125 lbs.

SIZE CODE	NOMINAL SIZE	APPROX NET WT.	DIM. A	DIM. B	DIM. C
0002LF	1/4	0.1283	0.72	0.72	0.44
0025LF	3/8	0.247	0.82	0.82	0.625
0050LF	1/2	0.369	1.01	1.01	0.625

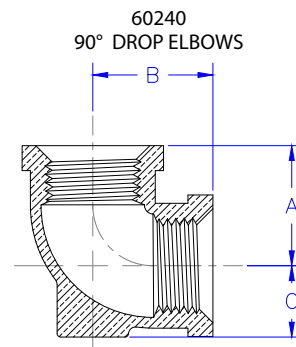

60254 STREET ELBOWS 125 lbs.

SIZE CODE	NOMINAL SIZE	APPROX NET WT.	DIM. A	DIM. B
0001LF	1/8	0.0523	0.54	0.92
0002LF	1/4	0.101	0.71	1.11
0025LF	3/8	0.135	0.82	1.24
0050LF	1/2	0.195	1.01	1.48
0100LF	3/4	0.323	1.18	1.65
0150LF	1	0.5887	1.43	1.98
0215LF	1-1/4	0.9427	1.69	2.24
0222LF	1-1/4x1	0.75	1.62	2.22
0295LF	1-1/2	1.2729	1.84	2.46
0390LF	2	2.1313	2.12	2.88
0520LF	2-1/2	4.06	2.7	3.86
0650LF	3	6.4835	3.08	4.51

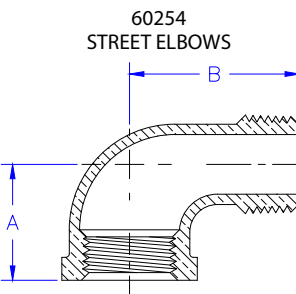

Domestic Cast Threaded Fittings

60290 45° ELBOWS 125 lbs.

SIZE CODE	NOMINAL SIZE	APPROX NET WT.	DIM. A	DIM. B
0001LF	1/8	0.054	0.42	0.42
0002LF	1/4	0.0912	0.56	0.56
0025LF	3/8	0.1372	0.63	0.63
0050LF	1/2	0.208	0.78	0.78
0100LF	3/4	0.311	0.89	0.89
0150LF	1	0.5395	1.06	1.06
0215LF	1-1/4	0.8	1.22	1.22
0295LF	1-1/2	1.0716	1.3	1.3
0390LF	2	1.7075	1.45	1.45
0520LF	2-1/2	3.28	1.95	1.95
0650LF	3	4.84	2.17	2.17

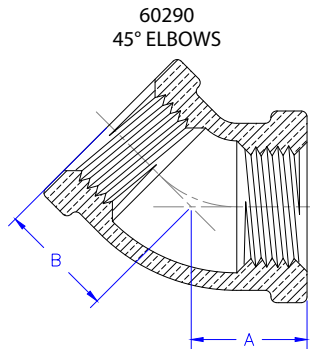

60295 45° STREET ELBOWS 125 lbs.

SIZE CODE	NOMINAL SIZE	APPROX NET WT.	DIM. A	DIM. B
0002LF	1/4	0.0753	0.56	0.88
0025LF	3/8	0.114	0.63	0.92
0050LF	1/2	0.1787	0.78	1.06
0100LF	3/4	0.294	0.89	1.23
0150LF	1	0.4875	1.06	1.4
0215LF	1-1/4	0.715	1.22	1.64
0295LF	1-1/2	0.931	1.3	1.8
0390LF	2	1.5686	1.45	2.14

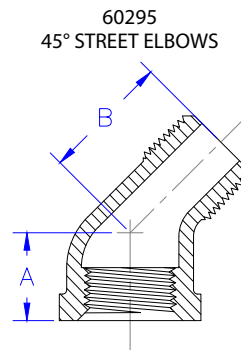

60335 EXTENSION PIECES 125 lbs.

SIZE CODE	NOMINAL SIZE	APPROX. NET WT.	DIM. A
0050LF	1/2	0.175	1.49
0100LF	3/4	0.238	1.74
0150LF	1	0.484	2.18
0215LF	1-1/4	0.59	2.02
0295LF	1-1/2	0.85	2.12
0390LF	2	1.2	2.3

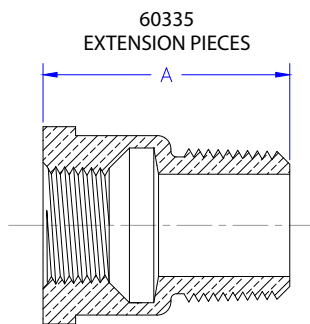

Domestic Cast Threaded Fittings

60355 FLOOR FLANGES 125 lbs.

SIZE CODE	NOMINAL SIZE	APPROX NET WT.	DIM. A	DIM. B
0002LF	1/4	0.1	2.47	0.36
0025LF	3/8	0.2193	2.67	0.47
0050LF	1/2	0.341	3	0.5
0100LF	3/4	0.405	3.25	0.55
0150LF	1	0.8339	3.72	0.78
0215LF	1-1/4	1.0527	4	0.75
0295LF	1-1/2	1.4905	4.38	0.92
0390LF	2	2.0503	5.09	0.98

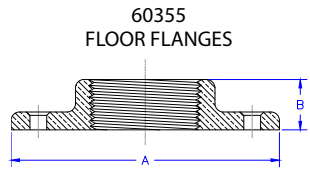

60375 LOCKNUTS 125 lbs.

SIZE CODE	NOMINAL SIZE	APPROX NET WT.	DIM. A	DIM. B
0001LF	1/8	0.0414	0.88	0.25
0002LF	1/4	0.035	0.88	0.25
0025LF	3/8	0.0338	1	0.28
0050LF	1/2	0.0692	1.28	0.27
0100LF	3/4	0.081	1.5	0.28
0150LF	1	0.112	1.75	0.34
0215LF	1-1/4	0.1712	2.09	0.38
0295LF	1-1/2	0.275	2.44	0.4
0390LF	2	0.385	2.94	0.47
0520LF	2-1/2	1.0233	3.75	0.56
0650LF	3	1.1092	4.25	0.63
0860LF	4	2.241	5.38	0.81

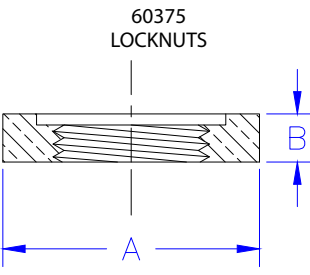

60396 REGULAR PLUGS 125 lbs.

SIZE CODE	NOMINAL SIZE	APPROX NET WT.	DIM. A
0050LF	1/2	0.0878	0.92
0100LF	3/4	0.12	0.99
0150LF	1	0.262	1.19
0215LF	1-1/4	0.3655	1.27
0295LF	1-1/2	0.4285	1.35
0390LF	2	0.6356	1.44
0520LF	2-1/2	1.0125	1.81
0650LF	3	1.45	1.93
0780LF	3-1/2	2.35	2.06
0860LF	4	2.668	2.14
1100LF	6	7.6949	2.51

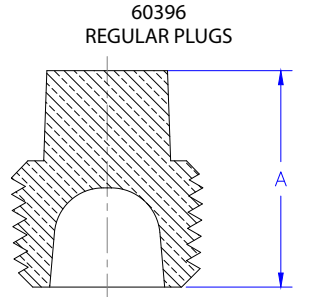

Domestic Cast Threaded Fittings

60397 COUNTERSUNK PLUGS 125 lbs.

SIZE CODE	NOMINAL SIZE	APPROX NET WT.	DIM. A
0050LF	1/2	0.0560	0.54
0100LF	3/4	0.0950	0.55
0150LF	1	0.2050	0.69
0215LF	1-1/4	0.3357	0.71
0295LF	1-1/2	0.4841	0.73
0390LF	2	0.7800	0.76
0520LF	2-1/2	1.6340	1.07
0650LF	3	2.5130	1.13
0860LF	4	2.8300	1.22
1100LF	6	12.2300	1.4

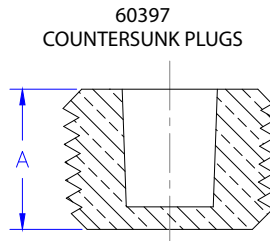

60399 SOLID PLUGS 125 lbs.

SIZE CODE	NOMINAL SIZE	APPROX NET WT.	DIM. A
0025LF	3/8	0.0558	0.72
0050LF	1/2	0.1085	0.92
0100LF	3/4	0.1776	0.99
0150LF	1	0.3614	1.19
0215LF	1-1/4	0.586	1.27
0295LF	1-1/2	0.8116	1.35
0390LF	2	1.343	1.44
0520LF	2-1/2	2.367	1.81
0650LF	3	3.7383	1.93
0860LF	4	7.01	2.14

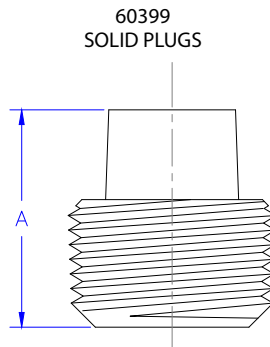

60460 TEES 125 lbs.

SIZE CODE	NOMINAL SIZE	APPROX NET WT.	DIM. A	DIM. B	DIM. C
0001LF	1/8	0.0941	0.54	0.54	0.54
0002LF	1/4	0.1291	0.71	0.71	0.71
0006LF	1/4x1/4x3/8	0.167	0.87	0.87	0.85
0007LF	1/4x1/4x1/8	0.1173	0.65	0.65	0.6
0025LF	3/8	0.213	0.82	0.82	0.82
0031LF	3/8x3/8x1/2	0.238	0.9	0.9	0.93
0032LF	3/8x3/8x1/4	0.174	0.75	0.75	0.78
0033LF	3/8x3/8x1/8	0.2	0.73	0.73	0.73
0040LF	3/8x1/4x3/8	0.1885	0.82	0.78	0.82
0050LF	1/2	0.3435	1.01	1.01	1.01
0056LF	1/2x1/2x1	0.568	1.31	1.31	1.25
0057LF	1/2x1/2x3/4	0.3795	1.11	1.11	1.08
0058LF	1/2x1/2x3/8	0.2534	0.93	0.93	0.9
0059LF	1/2x1/2x1/4	0.2297	0.87	0.87	0.87
0060LF	1/2x1/2x1/8	0.2337	0.87	0.87	0.87
0066LF	1/2x3/8x1/2	0.268	1.01	0.9	1.01

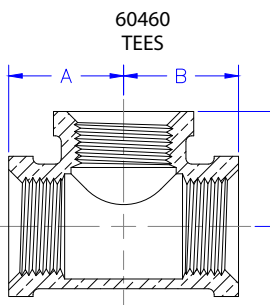

Domestic Cast Threaded Fittings

60460 TEES (continued)			125 lbs.		
SIZE CODE	NOMINAL SIZE	APPROX NET WT.	DIM. A	DIM. B	DIM. C
0067LF	1/2x3/8x3/8	0.2488	0.93	0.82	0.9
0075LF	1/2x1/4x1/2	0.2901	0.93	0.87	0.93
0100LF	3/4	0.4828	1.18	1.18	1.18
0104LF	3/4x3/4x1-1/2	1	1.7	1.7	1.34
0106LF	3/4x3/4x1	0.648	1.31	1.31	1.3
0107LF	3/4x3/4x1/2	0.411	1.08	1.08	1.11
0108LF	3/4x3/4x3/8	0.399	1	1	1
0109LF	3/4x3/4x1/4	0.346	1	1	1
0117LF	3/4x1/2x3/4	0.42	1.18	1.11	1.18
0118LF	3/4x1/2x1/2	0.401	1.08	1.01	1.11
0126LF	3/4x3/8x3/4	0.3562	1.18	1.08	1.18
0127LF	3/4x3/8x1/2	0.784	1.09	0.87	1.09
0150LF	1	1.15	1.43	1.43	1.43
0157LF	1x1x1-1/2	0.964	1.72	1.72	1.55
0158LF	1x1x1-1/4	0.7166	1.6	1.6	1.52
0159LF	1x1x3/4	0.5768	1.3	1.3	1.31
0160LF	1x1x1/2	0.5594	1.2	1.2	1.24
0161LF	1x1x3/8	0.585	1.12	1.12	1.13
0162LF	1x1x1/4	0.6854	1.06	1.06	1.15
0169LF	1x3/4x1	0.575	1.31	1.43	1.43
0170LF	1x3/4x3/4	0.463	1.3	1.18	1.31
0171LF	1x3/4x1/2	0.79	1.2	1.08	1.24
0180LF	1x1/2x1	0.51	1.43	1.24	1.43
0181LF	1x1/2x3/4	0.45	1.3	1.11	1.31
0182LF	1x1/2x1/2	1.1563	1.16	0.93	1.16
0215LF	1-1/4	1.7425	1.69	1.69	1.69
0221LF	1-1/4x1-1/4x1-1/2	1.0928	1.81	1.81	1.72
0222LF	1-1/4x1-1/4x1	0.908	1.52	1.52	1.6
0223LF	1-1/4x1-1/4x3/4	0.929	1.39	1.39	1.48
0224LF	1-1/4x1-1/4x1/2	0.9279	1.29	1.29	1.41
0234LF	1-1/4x1x1-1/4	0.9349	1.69	1.6	1.69
0235LF	1-1/4x1x1	0.85	1.52	1.41	1.6
0236LF	1-1/4x1x3/4	0.775	1.39	1.3	1.48
0237LF	1-1/4x1x1/2	1.0983	1.31	1.21	1.45
0245LF	1-1/4x3/4x1-1/4	0.72	1.69	1.48	1.69
0247LF	1-1/4x3/4x3/4	0.915	1.45	1.31	1.62
0256LF	1-1/4x1/2x1-1/4	1.5225	1.69	1.4	1.69
0295LF	1-1/2	2.145	1.84	1.84	1.84
0302LF	1-1/2x1-1/2x2	1.45	2.07	2.07	1.89
0303LF	1-1/2x1-1/2x1-1/4	1.348	1.72	1.72	1.81
0304LF	1-1/2x1-1/2x1	1.197	1.55	1.55	1.72
0305LF	1-1/2x1-1/2x3/4	1.12	1.42	1.42	1.6
0306LF	1-1/2x1-1/2x1/2	1.4722	1.32	1.32	1.53
0315LF	1-1/2x1-1/4x1-1/2	1.333	1.84	1.81	1.84
0316LF	1-1/2x1-1/4x1-1/4	1.5466	1.72	1.69	1.81
0328LF	1-1/2x1x1-1/2	1.24	1.94	1.8	1.94

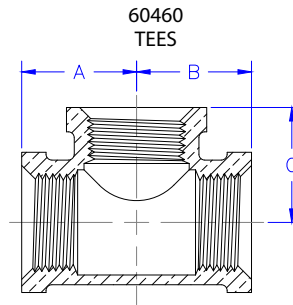

Domestic Cast Threaded Fittings

60460 TEES (continued)			125 lbs.		
SIZE CODE	NOMINAL SIZE	APPROX NET WT.	DIM. A	DIM. B	DIM. C
0329LF	1-1/2x1x1-1/4	1.15	1.8	1.53	1.8
0330LF	1-1/2x1x1	1.3525	1.5	1.65	1.8
0339LF	1-1/2x3/4x1-1/2	1.45	1.84	1.6	1.84
0350LF	1-1/2x1/2x1-1/2	2.6667	1.94	1.66	1.94
0390LF	2	3.76	2.12	2.12	2.12
0396LF	2x2x3	3.6667	2.78	2.78	2.4
0397LF	2x2x2-1/2	2.1122	2.6	2.6	2.39
0398LF	2x2-1-1/2	2.065	1.89	1.89	2.07
0399LF	2x2-1-1/4	1.91	1.77	1.77	2.04
0400LF	2x2x1	1.696	1.59	1.59	1.95
0401LF	2x2x3/4	1.6725	1.47	1.47	1.84
0402LF	2x2x1/2	2.345	1.49	1.49	1.88
0413LF	2x1-1/2x2	1.96	2.12	2.07	2.12
0414LF	2x1-1/2x1-1/2	1.85	1.89	1.84	2.07
0415LF	2x1-1/2x1-1/4	1.6364	1.77	1.62	1.93
0416LF	2x1-1/2x1	2.0984	1.77	1.39	1.93
0429LF	2x1-1/4x2	2.4675	2.12	1.94	2.12
0444LF	2x1x2	2.5566	2.12	2.02	2.12
0457LF	2x3/4x2	1.83	2.12	2.02	2.12
0458LF	2x3/4x1-1/2	1.830	2.44	2.25	2.25
0520LF	2-1/2	4.5564	2.7	2.7	2.7
0531LF	2-1/2x2-1/2x2	4.0875	2.39	2.39	2.6
0532LF	2-1/2x2-1/2x1-1/2	3.755	2.44	2.44	2.63
0533LF	2-1/2x2-1/2x1-1/4	3	2.04	2.04	2.45
0534LF	2-1/2x2-1/2x1	2.9833	1.87	1.87	2.37
0535LF	2-1/2x2-1/2x3/4	3.0766	1.74	1.74	2.32
0548LF	2-1/2x2x2-1/2	4.18	2.7	2.6	2.7
0549LF	2-1/2x2x2	2.829	2.39	2.25	2.6
0564LF	2-1/2x1-1/2x2	3.515	2.7	2.51	2.7
0650LF	3	6.705	3.08	3.08	3.08
0662LF	3x3x2-1/2	6.45	2.83	2.83	2.99
0663LF	3x3x2	5.545	2.52	2.52	2.89
0664LF	3x3x1-1/2	5	2.29	2.29	2.8
0666LF	3x3x1	4.39	2	2	2.66
0678LF	3x2-1/2x2-1/2	5.97	2.7	2.83	2.99
0693LF	3x2x3	6.14	3.08	2.89	3.08
0695LF	3x2x2	3.4025	2.52	2.25	2.89
0780LF	3-1/2	8.2396	3.32	3.32	3.32
0860LF	4	11.353	3.79	3.79	3.79
0872LF	4x4x2	8	2.74	2.74	3.41
0975LF	5	21.7	4.5	4.5	4.5
1100LF	6	33.66	5.13	5.13	5.13

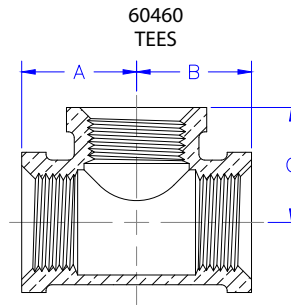

Domestic Cast Threaded Fittings

60467 DROP TEES 125 lbs.

SIZE CODE	NOMINAL SIZE	APPROX NET WT.	DIM. A	DIM. B	DIM. C	DIM. D
0025LF	3/8	0.251	0.82	0.53	0.82	0.82

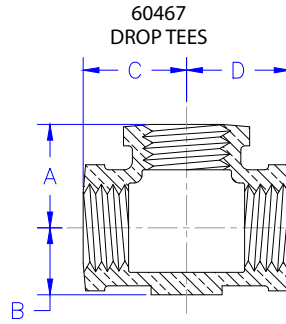

60486 STREET TEES 125 lbs.

SIZE CODE	NOMINAL SIZE	APPROX NET WT.	DIM. A	DIM. B	DIM. C
0025LF	3/8	0.2151	0.82	1.24	0.82
0050LF	1/2	0.27	1.01	1.48	1.01
0100LF	3/4	0.4587	1.18	1.65	1.18
0150LF	1	0.79	1.43	1.98	1.43
0215LF	1-1/4	1.34	1.69	2.24	1.69
0390LF	2	2.56	2.12	2.88	2.12

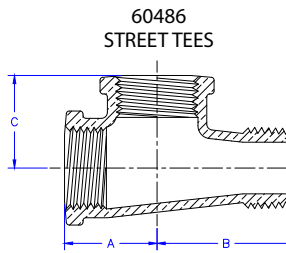

60840 45° Y-BRANCHES 125 lbs.

SIZE CODE	NOMINAL SIZE	APPROX NET WT.	DIM. A	DIM. B
0002LF	1/4	0.1805	1.78	1.28
0025LF	3/8	0.23	1.78	1.28
0050LF	1/2	0.3023	2.19	1.58
0100LF	3/4	0.6466	2.62	1.9
0150LF	1	0.9733	3.18	2.33
0215LF	1-1/4	1.717	3.85	2.83
0295LF	1-1/2	2.201	4.24	3.14
0390LF	2	3.197	5	3.76
0520LF	2-1/2	6.39	6.25	4.73
0650LF	3	10.19	7.26	5.55

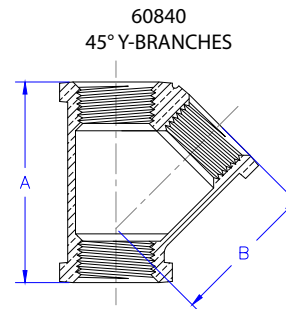

Domestic Cast Threaded Fittings

61657 STANDARD UNIONS 125 lbs.

SIZE CODE	NOMINAL SIZE	APPROX NET WT.	DIM. A
0002LF	1/4	0.15	1.44
0025LF	3/8	0.45	1.63
0050LF	1/2	0.4	1.81
0100LF	3/4	0.75	2
0150LF	1	1.15	2.19
0215LF	1-1/4	1.425	2.44
0295LF	1-1/2	2.02	2.63
0390LF	2	3.14	2.94

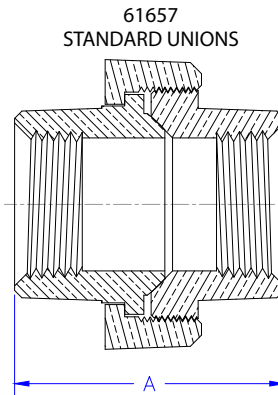

63155 EXTRA HEAVY CAPS 250 lbs.

SIZE CODE	NOMINAL SIZE	APPROX NET WT.	DIM. A
0050LF	1/2	0.2255	0.76
0100LF	3/4	0.373	0.84
0150LF	1	0.6	0.99
0215LF	1-1/4	1.05	1.1
0295LF	1-1/2	1.24	1.15
0390LF	2	2.0933	1.32

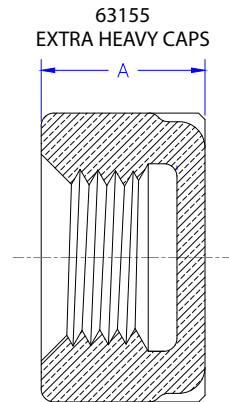

63165 EXTRA HEAVY COUPLINGS 250 lbs.

SIZE CODE	NOMINAL SIZE	APPROX NET WT.	DIM. A
0002LF	1/4	0.1457	1.06
0025LF	3/8	0.241	1.16
0050LF	1/2	0.3587	1.34
0100LF	3/4	0.5726	1.52
0107LF	3/4x1/2	0.45	1.36
0150LF	1	0.9117	1.67
0159LF	1x3/4	0.7048	1.7
0160LF	1x1/2	0.75	2
0215LF	1-1/4	1.37	1.93
0222LF	1-1/4x1	1.2183	2.13
0295LF	1-1/2	1.7948	2.15
0303LF	1-1/2x1-1/4	1.674	2.25
0304LF	1-1/2x1	1.45	2.25
0390LF	2	2.756	2.53
0398LF	2x1-1/2	2.3	2.32
0520LF	2-1/2	4.1	2.88
0531LF	2-1/2x2	3.4167	2.63

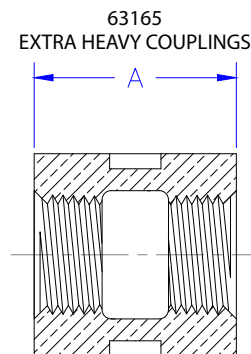

Domestic Cast Threaded Fittings

63195 EXTRA HEAVY CROSSES 250 lbs.

SIZE CODE	NOMINAL SIZE	APPROX NET WT.	DIM. A	DIM. B
0050LF	1/2	0.711	1.12	1.12
0100LF	3/4	1.236	1.31	1.31
0150LF	1	1.95	1.5	1.5
0215LF	1-1/4	2.92	1.75	1.75
0295LF	1-1/2	4.06	1.94	1.94
0390LF	2	5.75	2.25	2.25

63195
EXTRA HEAVY CROSSES

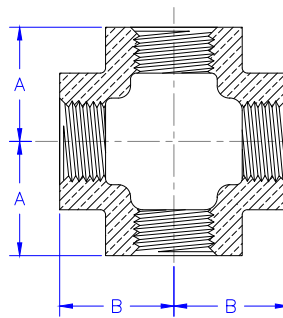

63235 EXTRA HEAVY ELBOWS 250 lbs.

SIZE CODE	NOMINAL SIZE	APPROX NET WT.	DIM. A	DIM. B
0002LF	1/4	0.167	0.81	0.81
0025LF	3/8	0.291	0.95	0.95
0050LF	1/2	0.4737	1.12	1.12
0100LF	3/4	0.6703	1.31	1.31
0150LF	1	1.312	1.5	1.5
0215LF	1-1/4	1.812	1.75	1.75
0295LF	1-1/2	2.595	1.94	1.94
0390LF	2	3.536	2.25	2.25
0520LF	2-1/2	5.575	2.7	2.7
0650LF	3	8.2	3.08	3.08

63235
EXTRA HEAVY ELBOWS

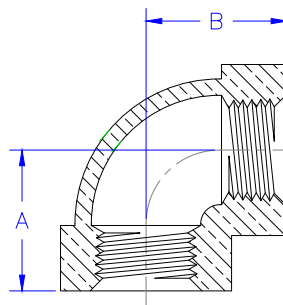

63254 EXTRA HEAVY STREET ELBOWS 250 lbs.

SIZE CODE	NOMINAL SIZE	APPROX NET WT.	DIM. A	DIM. B
0150LF	1	0.8485	1.43	1.98
0295LF	1-1/2	2.1002	1.84	2.46

63254
EXTRA HEAVY STREET ELBOWS

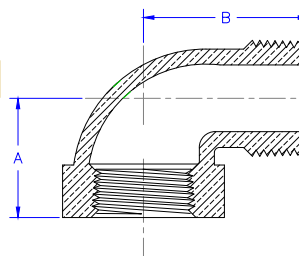

Domestic Cast Threaded Fittings

63290 EXTRA HEAVY 45° ELBOWS 250 lbs.

SIZE CODE	NOMINAL SIZE	APPROX NET WT.	DIM. A	DIM. B
0050LF	1/2	0.4	0.88	0.88
0100LF	3/4	0.611	0.98	0.98
0150LF	1	0.9592	1.12	1.12
0215LF	1-1/4	1.54	1.29	1.29
0295LF	1-1/2	2.1035	1.43	1.43
0390LF	2	3.205	1.68	1.68
0520LF	2-1/2	5	1.95	1.95
0650LF	3	7.250	2.17	2.17

63290
EXTRA HEAVY 45° ELBOWS

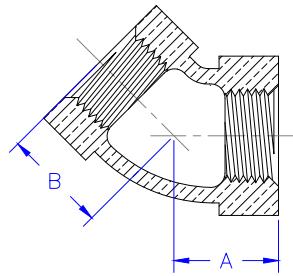

63460 EXTRA HEAVY TEES 250 lbs.

SIZE CODE	NOMINAL SIZE	APPROX NET WT.	DIM. A	DIM. B	DIM. C
0002LF	1/4	0.209	0.81	0.81	0.81
0025LF	3/8	0.354	0.95	0.95	0.95
0050LF	1/2	0.64	1.12	1.12	1.12
0059LF	1/2x1/2x1/4	0.51	0.87	0.87	0.87
0100LF	3/4	1.048	1.31	1.31	1.31
0150LF	1	1.556	1.5	1.5	1.5
0159LF	1x1x3/4	1.3	1.37	1.37	1.45
0160LF	1x1x1/2	1.155	1.26	1.26	1.36
0180LF	1x1/2x1	1.0646	1.5	1.38	1.5
0215LF	1-1/4	2.432	1.75	1.75	1.75
0224LF	1-1/4x1-1/4x1/2	1.6308	1.33	1.33	1.53
0295LF	1-1/2	3.15	1.94	1.94	1.94
0390LF	2	5.05	2.25	2.25	2.25
0402LF	2X2X1/2	7.55	1.49	1.49	1.88
0520LF	2-1/2	7.55	2.7	2.7	2.7
0860LF	4	19	3.79	3.79	3.79

63460
EXTRA HEAVY TEES

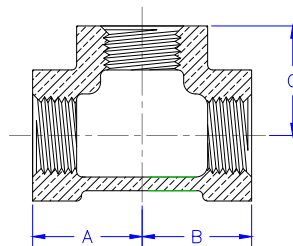

64657 EXTRA HEAVY UNIONS 250 lbs.

SIZE CODE	NOMINAL SIZE	PKG. QTY.	APPROX NET WT.	DIM. A
0002LF	1/4	150	0.35	1.56
0025LF	3/8	100	0.5	1.75
0050LF	1/2	50	0.66	2
0100LF	3/4	40	1.05	2.125
0150LF	1	40	1.65	2.44
0215LF	1-1/4	20	2.356	2.69
0295LF	1-1/2	20	2.95	2.81
0390LF	2	10	3.95	3.18
0520LF	2-1/2	5	5.65	3.62
0650LF	3	5	8.8	3.69

64657
EXTRA HEAVY UNIONS

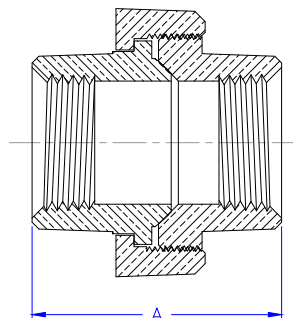

Domestic Cast Threaded Fittings

64668 EXTRA HEAVY UNION ELBOWS 250 lbs.

SIZE CODE	NOMINAL SIZE	APPROX NET WT.	DIM. A	DIM. B
0025LF	3/8	0.66	0.94	2.125
0050LF	1/2	0.85	1.125	2.31
0100LF	3/4*	1.55	1.31	2.56
0150LF	1	1.95	1.5	2.94
0215LF	1-1/4	2.95	2.04	3.7
0295LF	1-1/2	3.9	1.94	3.62
0390LF	2*	5.2	2.25	4.12

*Elbows on these unions sizes are 125 class

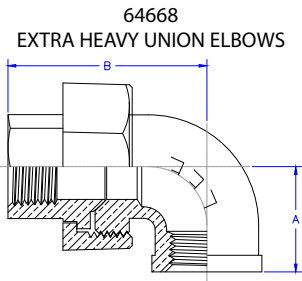

Domestic Cast Threaded Flanges

In addition to various specialty flanges, Lee manufactures a complete line of standard flanges as listed below:

150# and 300# threaded flange dimensions (including blind flanges) conform to ANSI B16.24. Consult factory for quotations on all other flanges.

32342 STANDARD BRONZE COMPANION FLANGE* 150 lb

SIZE CODE	NOMINAL SIZE	APPROX NET WT.	DIM. A	DIM. B	DIM. C	DIM. D	DIM. E	DIM. F
0050LF	1/2	0.97	3.5	2.38	0.59	0.63	0.31	4
0100LF	3/4	1.36	3.88	2.75	0.63	0.63	0.34	4
0150LF	1	1.78	4.25	3.12	0.69	0.63	0.38	4
0215LF	1-1/4	2.11	4.63	3.5	0.81	0.63	0.41	4
0295LF	1-1/2	2.86	5	3.88	0.88	0.63	0.44	4
0390LF	2	4.304	6	4.75	1	0.75	0.5	4
0520LF	2-1/2	6.72	7	5.5	1.12	0.75	0.56	4
0650LF	3	8.535	7.5	6	1.19	0.75	0.63	4
0860LF	4	12.41	9	7.5	1.31	0.75	0.69	8
0975LF	5	13.83	10	8.5	1.44	0.88	0.75	8
1100LF	6	18.2	11	9.5	1.56	0.88	0.81	8

*Steam 150 lbs./sq. in., Non-shock cold WOG 225 lbs.

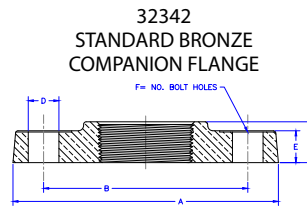

32343 BLIND FLANGE* 150 lb

SIZE CODE	NOMINAL SIZE	APPROX NET WT.	DIM. A	DIM. B	DIM. C	DIM. D	DIM. E
0390LF	2	4.1333	6	4.75	4	0.75	0.5
0520LF	2-1/2	7.0800	7	5.5	4	0.75	0.56
0650LF	3	8.9400	7.5	6	4	0.75	0.63
0860LF	4	13.9700	9	7.5	8	0.75	0.69
0975LF	5	18.0100	10	8.5	8	0.88	0.75
1100LF	6	25.1667	11	9.5	8	0.88	0.81

*Steam 150 lbs./sq. in., Non-shock cold WOG 225 lbs.

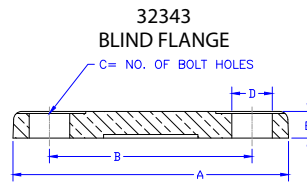

32345 EXTRA HEAVY BRONZE COMPANION FLANGE* 300 lb

SIZE CODE	NOMINAL SIZE	APPROX NET WT.	DIM. A	DIM. B	DIM. C	DIM. D	DIM. E	DIM. F
0295LF	1-1/2	6.1600	6.12	4.5	0.88	0.88	0.69	4
0390LF	2	6.5500	6.5	5	1	0.75	0.78	8
0520LF	2-1/2	8.6400	7.5	5.88	1.12	0.88	0.81	8
0650LF	3	12.6600	8.25	6.63	1.19	0.88	0.9	8
0860LF	4	20.4412	10	7.88	1.31	0.88	1.09	8

*Steam 300 lbs./sq. in., Non-shock cold WOG 500 lbs.

